

# TAC-3, TA(N)2-3 SERIES

## 4x7 SMT & Right Angle

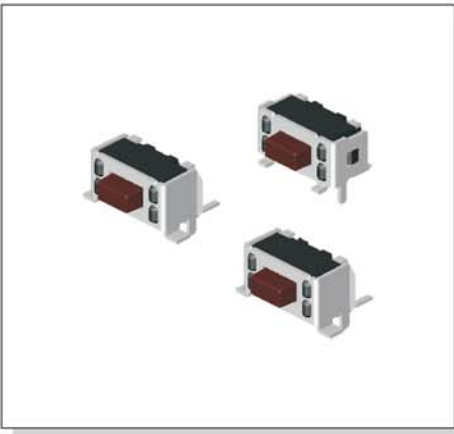

### HOW TO ORDER

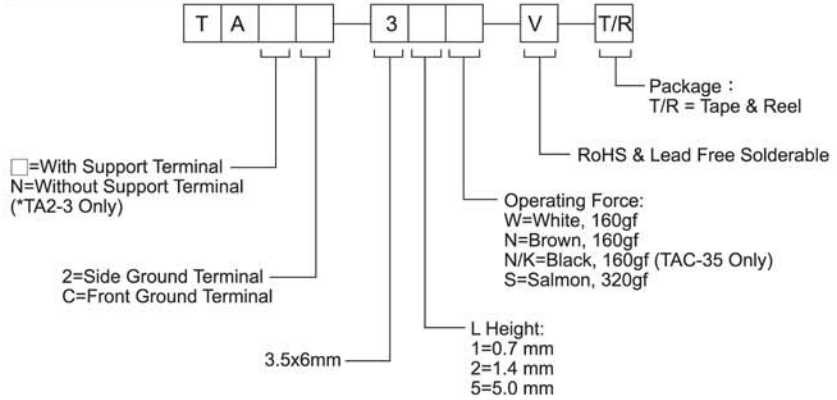

### SPECIFICATION

#### MECHANICAL

Operation Force: 320 ± 50gf Salmon (S)  
160 ± 50gf White (W)  
Stroke : 0.25+0.1/-0.2mm

#### ENVIRONMENTAL

Operation Temperature Range : -25°C to +70°C  
Storage Temperature Range : -30°C to +80°C

#### ELECTRICAL

Electrical Life : 50,000 cycles  
Rating : 50mA, 12VDC

#### PACKAGE

Tape and Reel: 900 pcs/reel

### CIRCUIT

#### TAC-3

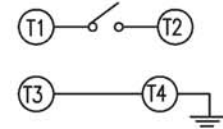

#### TA(N)2-3

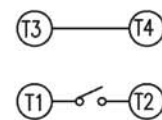

### TAC-3

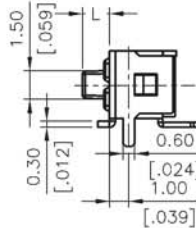
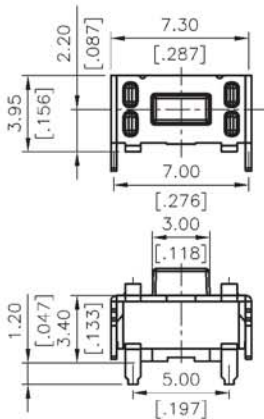

TAC-35	5.00[.196]
TAC-32	1.40[.055]
TAC-31	0.70[.027]
PART NO.	H

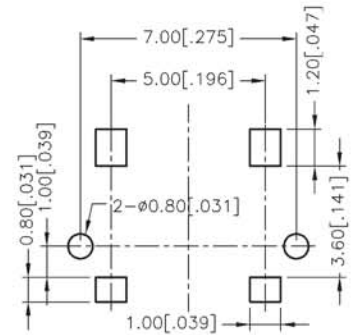

P.C.B LAYOUT

### TAN2-3

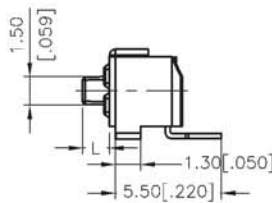
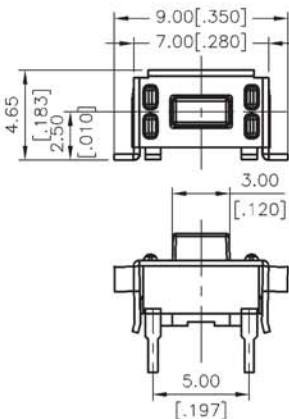

TAN2-32	1.40[.055]
TAN2-31	0.70[.027]
PART NO.	H

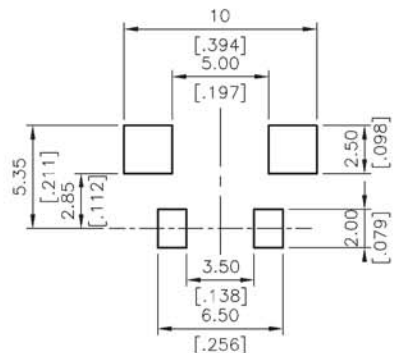

P.C.B LAYOUT

General Tolerance: ±0.2mm( ±0.008")